



AIRFACE

PERFORATED DESIGN FOR
UNOBSTRUCTED VENTILATION

FEATURES

特點 / 特点

ENGLISH

- Perforated design for unobstructed ventilation
- Innovative quick slide dust filter
- Support for E-ATX motherboard
- Up to 330mm graphics cards
- Up to five fans and 190mm CPU cooler

RUSSIAN

- Перфорированная конструкция для беспрепятственной вентиляции
- Инновационный быстросъемный пылевой фильтр
- Поддержка материнской платы E-ATX
- Вмещает видеокарту длиной до 330 мм
- Вмещает до пяти вентиляторов и 190-мм процессорный кулер

SPANISH

- Diseño perforado para una ventilación sin obstáculos
- Innovador filtro de polvo de deslizamiento rápido
- Soporte para placa base E-ATX
- Tarjetas gráficas de hasta 330 mm
- Hasta cinco ventiladores y un cooler de CPU de 190 mm

BRAZILIAN PORTUGUESE

- Desing perfurado para ventilação sem obstruções
- Inovador filtro de pó de deslizamento rápido
- Suporte para a placa-mãe E-ATX
- Placas gráficas de até 330mm
- Até cinco ventiladores e um CPU Cooler de 190mm

GERMAN

- Perforiertes Design für ungehinderte Luftzirkulation
- Innovativer Staubfilter mit Schnellverschluss
- Unterstützung für E-ATX-Motherboards
- Grafikkarten bis zu 330 mm
- Bis zu fünf Lüfter und 190-mm-CPU-Kühler

KOREAN

- 방해받지 않는 환기를 위한 천공 설계
- 혁신적인 퀵 슬라이드 먼지 필터
- E-ATX 마더보드 지원
- 최대 330mm 그래픽 카드 장착 가능
- 최대 5개의 팬 및 190mm CPU 쿨러 장착 가능

日本語

- ヌッシュデザインで放熱性に優れています
- 革新的なスライド防塵フィルター
- E-ATXマザーボードもサポート
- 最大330mmのグラフィックカードに対応できます
- 最大5つのファンと190mmのCPUクーラーを搭載可能

中文

- 网孔面板带来畅通无阻散热气流
- 侧拉式快拆防尘滤网
- 支援E-ATX 主机板
- 最高支援330mm 显卡
- 最高支援5个风扇和190mm CPU散热器

ASSEMBLY DRAWING

爆炸圖 / 爆炸图

- A** Airflow front panel
金屬網孔前飾板 / 金属网孔前饰板
- B** Quick slide dust filter
側拉式快拆防塵濾網 / 侧拉式快拆防尘滤网
- C** 2 x 120mm / 2 x 140mm fans for front panel
前板支援2 x 120mm / 2 x 140mm風扇
前板支援2 x 120mm / 2 x 140mm 风扇
- D** Air filter for bottom panel
底部防塵網 / 底部防尘网
- E** Tempered glass side panel
玻璃左側板 / 玻璃左侧板
- F** Vertical slot covers
垂直擴充插槽 / 垂直扩充插槽
- G** 1 x 120mm / 1 x 140mm fan for rear panel
(120mm Black fan x 1 pre-installed)
背板支援1 x 120mm / 1 x 140mm 風扇
(預裝120mm 黑色風扇x 1)
- H** Air filter for top panel
上蓋防塵網 / 上盖防尘网
- I** 2 x 120mm / 2 x 140mm fans for top panel
上蓋支援2 x 120mm / 2 x 140mm 風扇
上盖支援2 x 120mm / 2 x 140mm 风扇
- J** 2.5"SSD tray
2.5" SSD托盤 / 2.5" SSD托盘
- K** Right side panel
右側板 / 右侧板
- L** 3.5"HDD cage
3.5" HDD 硬碟槽 / 3.5" HDD硬盘槽

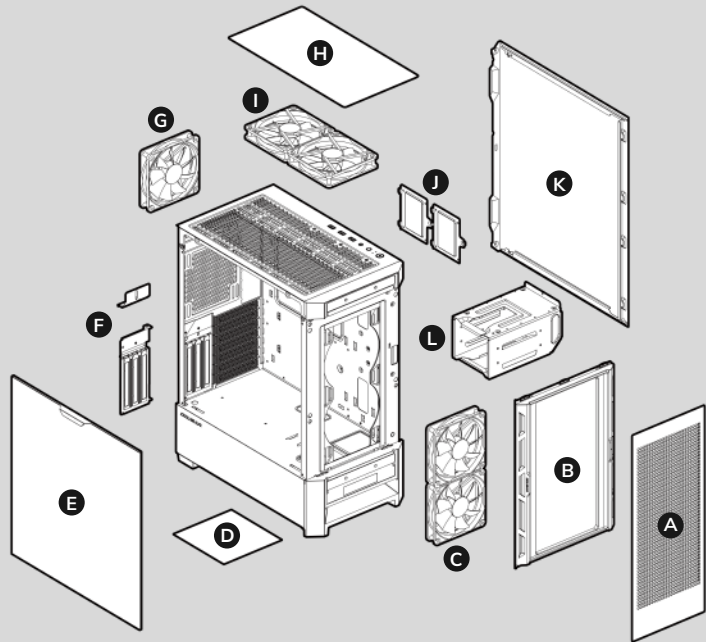

SPECIFICATIONS

規格 / 规格







Product Name 產品名稱 / 产品名称	Airface
Case Form Factor 機箱規格 / 机箱规格	Mid Tower / 中塔機箱 / 中塔机箱
Motherboard Type 主板類型 / 主板类型	Mini ITX / Micro ATX / ATX / CEB / *E-ATX
Dimension 尺寸(寬 x 高 x 深) / 尺寸(宽x高x深)	230(W) x 491(H) x 386(D) (mm) / 9.1(W) x 19.3(H) x 15.2(D) (in)
I/O Panel I/O 接口	USB 3.0 x 2, USB 2.0 x 1, 4 Pole Headset Audio Jack x1, Reset Button
3.5" Drive Bay 3.5" 硬碟槽 / 3.5" 硬盘槽	2
2.5" Drive Bay 2.5" 硬碟槽 / 2.5" 硬盘槽	3 (2 SSD trays included) / 2 (內附2個SSD硬碟托盤) / 2 (內附2个SSD硬盘架)
Expansion Slots 擴充插槽 / 扩充插槽	7+3
Cooling Fan Support 散熱風扇規格 / 散热风扇规格	Front / 前板 : 120mm x 2 / 140mm x 2
	Top / 上蓋 / 上盖 : 120mm x 2 / 140mm x 2
	Rear / 背板 : 120mm x 1 / 140mm x 1 (120mm Black fan x 1 pre-installed) (預裝120mm 黑色風扇 x 1) / (預裝120mm 黑色風扇 x 1)
Maximum Number of Fans 最高風扇安裝數量 最高风扇安装数量	5

Water Cooling Radiator Support 水冷排規格 / 水冷排规格	Front / 前板 : *280mm / 240mm / 140mm / 120mm
	Top / 上蓋 / 上盖 : *280mm / 240mm / 140mm / 120mm
	Rear / 背板 : 140mm / 120mm
Transparent Left Panel 透明左側蓋 / 透明左侧盖	4mm Tempered Glass / 4mm鋼化玻璃 / 4mm 钢化玻璃
Max. Graphics Card Length 顯卡最大長度 显卡最大长度	330(mm) / 13(in)
Max. CPU Cooler Height CPU 風扇最大高度 CPU 风扇最大高度	190(mm) / 7.5(in)
Max. PSU Length 電源供應器最大長度 电源供应器最大长度	160(mm) / 6.3(in)

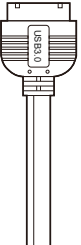
- E-ATX up to 277mm wide. / E-ATX 主板最高可支援寬度為277mm / E-ATX 主板最高可支援宽度为 277 mm。
- Please choose either front or top to install a 280mm radiator.
280 mm 水冷排請擇一安裝於前板或上蓋 / 280 mm 水冷排请择一安装于前板或上盖。
- Max. length of RTX 3090 graphic card is 325mm. / RTX 3090 顯卡長度最大為325mm / RTX 3090 显卡长度最大为 325 mm。











INSTALLING THE I / O CONNECTORS

I/O 線材接頭 / I/O 线材接头

USB 3.0	USB 2.0	HD AUDIO HD音效線 HD音效线	POWER SW 電源開關線 电源开关线	POWER LED 電源 LED 燈線 电源 LED 灯线	H.D.D LED H.D.D LED 燈線 H.D.D LED 灯线	RESET SW 重啟開關線 重启开关线
						

ACCESSORY KIT

配件包

		3.5" HDD screws / 3.5" HDD 螺絲 / 3.5" HDD 螺丝	X 8
		Motherboard screws and 2.5" SSD screws 主機板螺絲 / 2.5" SSD 螺絲 / 主机板螺絲 / 2.5" SSD 螺絲	X 17
		Power supply screws 電源螺絲 / 电源螺絲	X 7
		Stand off for motherboard and VGA riser cable 主機板銅柱 / 垂直顯卡排線銅柱 / 主机板铜柱 / 垂直显卡排线铜柱	X 5
		3.5" HDD cage screws 3.5" HDD 硬碟槽手動螺絲 / 3.5" HDD 硬盘槽手动螺絲	X 1
		Cable ties 束線帶 / 束线带	X 6

REMOVING PANELS

前面板與左右側板拆卸說明 / 前面板与左右侧板拆卸说明

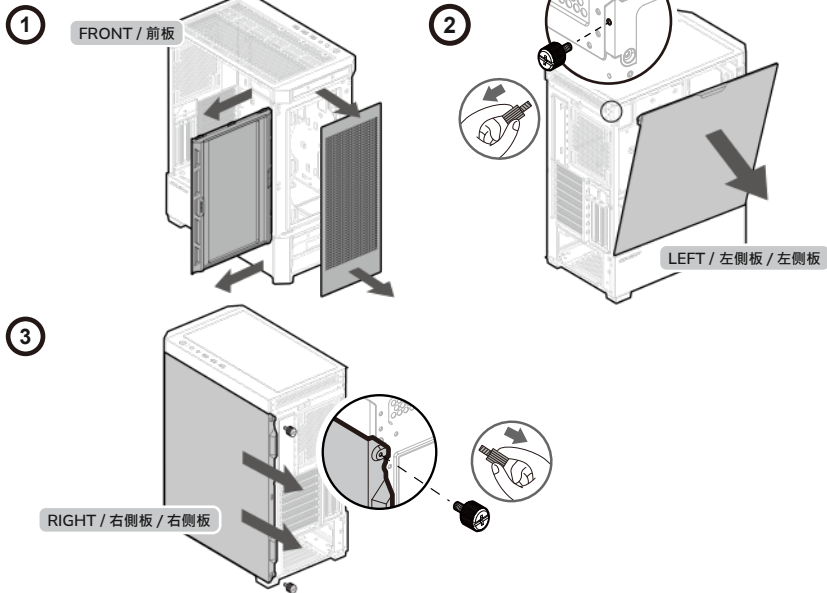

INSTALLING WATER COOLING RADIATORS & COOLING FANS

水冷與風扇安裝說明 / 水冷与风扇安装说明

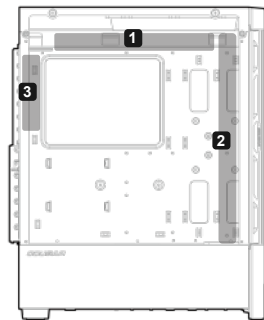

1 (Top / 上蓋 / 上蓋)



2 (Front / 前板)

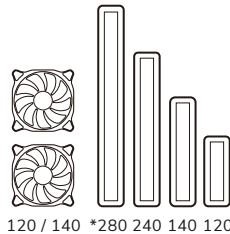

3 (Rear / 背板)

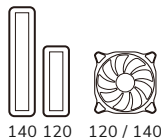

- Please choose either front or top to install a 280mm radiator.
- 280 mm 水冷排請擇一安裝於前板或上蓋。
- 280 mm 水冷排請擇一安裝於前板或上蓋。

INSTALLING THE 3.5" HDDS

3.5" HDD 安裝說明 / 3.5" HDD 安裝说明

3.5" HDDS

RIGHT / 右側 / 右側

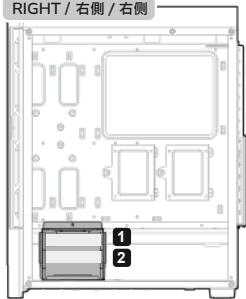

①

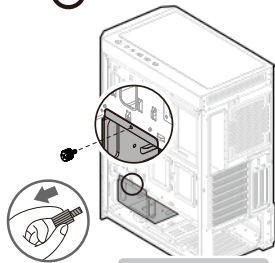

RIGHT / 右側 / 右側

②

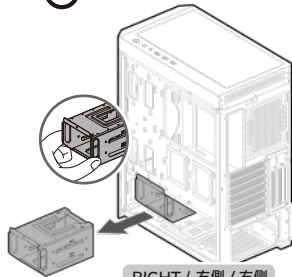

RIGHT / 右側 / 右側

③

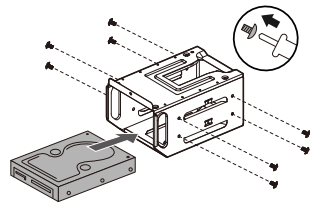

INSTALLING THE 2.5" SSDS

2.5" SSD 安裝說明 / 2.5" SSD 安裝說明

2.5" SSDS

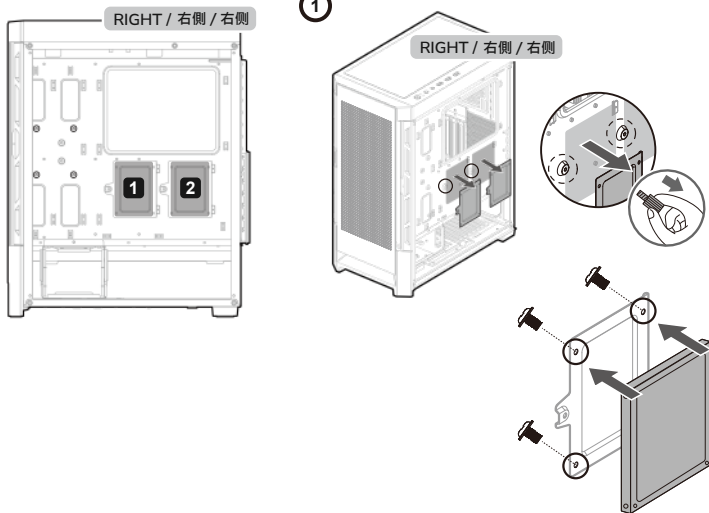

2.5" SSDS

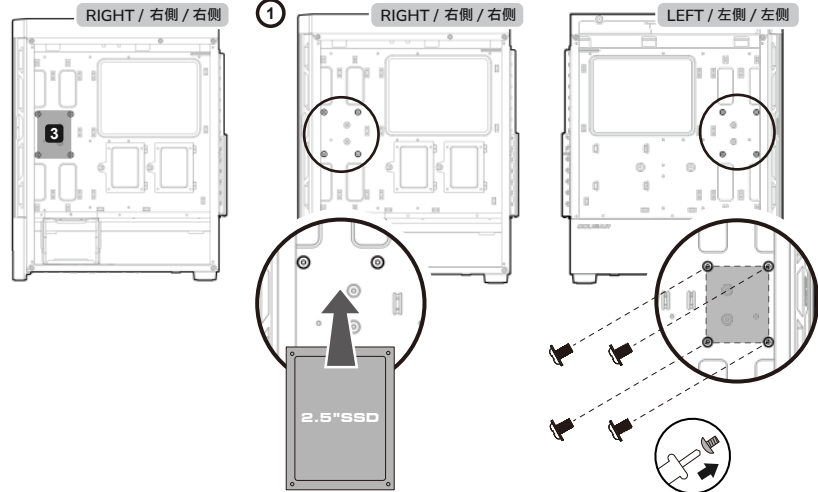



INSTALLING GRAPHIC CARD

顯卡安裝說明 / 显卡安装说明

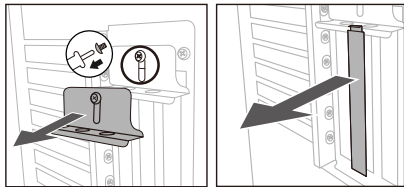
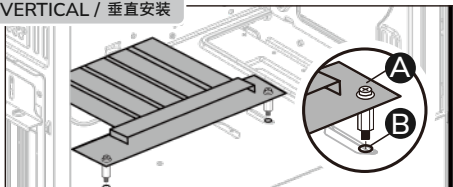
VERTICAL / 垂直安裝



- A**  Motherboard screws / 2.5" SSD screws
主機板螺絲 / 2.5" SSD螺絲
- B**  Stand-off for VGA riser cable
主機板銅柱 / 垂直顯卡排線銅柱

 The vertical graphic card and the PCI-E riser cable are not included in the package, please purchase separately.
顯卡和 PCI-E 轉接線不包含在包裝內，請單獨購買。
显卡和 PCI-E 转接线不包含在包裝內，請单独购买。

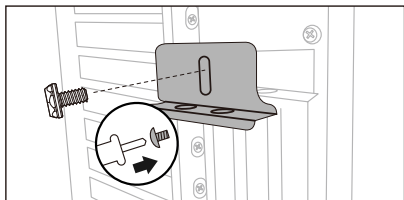
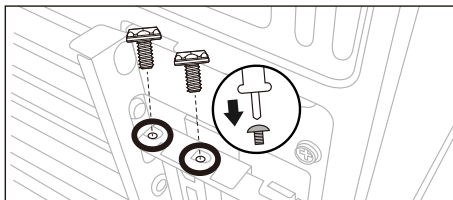
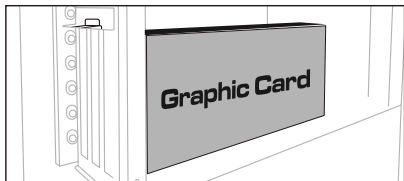

HORIZONTAL / 水平安裝

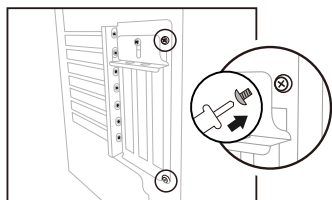
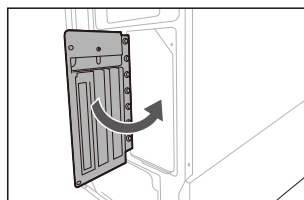
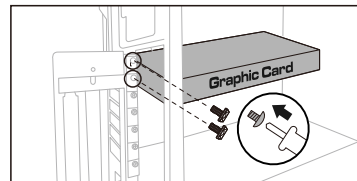
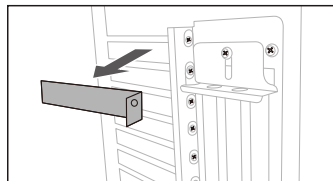
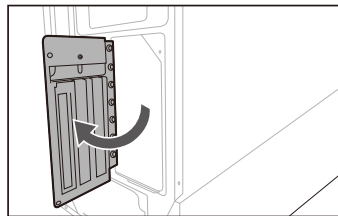
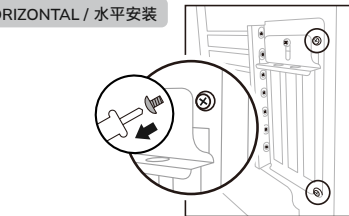

ДАТА ИЗГОТОВЛЕНИЯ ПРОДУКЦИИ

год и месяц изготовления продукции указаны в серийном номере продукта.
(существует 2 способа определения даты изготовления, оба способа описаны ниже)

- А** После S/N: первые две цифры означают год, вторые две – месяц изготовления.
Например, S/N: H**2202**000001 означает, что товар был произведен в феврале 2022 года.
- Б** После S/N: если указаны буквы, то две буквы представляют цифры из таблицы ниже, и означают год, последующие две цифры – месяц изготовления.
Например, S/N: D**BB02**REVI000001 означает, что товар был произведен в феврале 2022 года.

A	B	C	D	E	F	G	H	I	J
1	2	3	4	5	6	7	8	9	0

• Например,
BB = 22 = 2022 год

تعليمات التركيب و الأمان:

- عند التركيب أو التفكيك يجب التأكد من أن جميع الأسلاك مفضولة عن الكهرباء.

- يجب اتخاذ الاحتراوات اللازمة لمنع الصعق الكهربائي.

- يجب إرتداء الملابس المناسبة أثناء تركيب/ تجميع الكمبيوتر.

- يجب تركيب كل قطعة بحذر و بمكانها المناسب.

- من يقوم بعملية التركيب الشخص المختص فقط.

БЪЛГАРИЯ

- Подробни инструкции за употреба изтеглете от: <https://cougargaming.com/bg>



България QR код

GLOBAL WARRANTY POLICY

全球保固條款 / 全球保固條款

WARRANTY PERIODS OF COUGAR GAMING DEVICES / COUGAR 電競產品保固期 / 电竞产品保固期

Product / 產品名稱 / 产品名称 : COUGAR AIRFACE

Warranty / 保固期 : 1 Year / 1年

- This warranty gives you specific legal rights. You may also have other rights granted under local law. These rights may vary.
本保固條款賦予您特定的合法權利，而您所在的地區可能也會賦予您其他權利。
本保固條款賦予您特定的合法權利，而您所在的地區可能也會賦予您其他權利。
- Only for electrical components.
僅適用於電子元件 / 仅适用于电子元件。



详细保固条款
请扫描二维码



Official website



COUGAR USA Technical Service
Tel: (833) 256-3778
Mail: rma@compucaseusa.com

Compucase Enterprise Co.,Ltd.
All rights reserved.

CE Made in China