

POSEIDON ULTRA ARGB

The Coming of Winter

FEATURES 特点, 特點

ENGLISH

- Perfect ratio of radiator fan performance to noise.
- Fan frame design generates vortex for optimum airflow.
- Corner dampeners suppress oscillation, reducing vibration noise.
- Grooved impeller lets you experience silent gaming.
- Maxed out conduction parameters: coolant flow, fin surface area, cooling plate thickness.
- Copper cooling plate compatible with latest intel LGA1851 and AMD AM5 sockets.
- 5 year warranty.

RUSSIAN

- Идеальное соотношение производительности вентилятора радиатора к шуму.
- Дизайн рамы вентилятора генерирует вихрь для оптимального воздушного потока.
- Угловые демпфины подавляют колебания, уменьшая вибрационный шум.
- Гребное рабочее колесо позволяет вам испытать беззвучные игры.
- Максимальные параметры проводимости: поток охлаждающей жидкости, площадь поверхности плавника, толщина охлаждающей пластины.
- Медная охлаждающая пластина, совместимая с новейшими разъемами Intel LGA1851 и AMD AM5
- 5-летняя гарантия

PORTUGUÊS

- Proporção perfeita de desempenho do ventilador do radiador e ruído.
- O design do quadro do ventilador gera vórtice para o fluxo de ar ideal.
- Os amortecedores do canto suprimem a oscilação, reduzindo o ruído de vibração.
- O impulsor ranhurado permite que você experimente jogos silenciosos.
- Parâmetros de condução máximos: fluxo de refrigerante, área de superfície da barbatana, espessura da placa de resfriamento.
- Placa de resfriamento de cobre compatível com os últimos soquetes Intel LGA1851 e AMD AM5.
- Garantia de 5 anos.

KOREAN

- 라디에이터 팬 성능과 노이즈의 완벽한 비율.
- 팬 프레임 디자인은 최적인 공기 흐름을 위한 소용돌이를 생성합니다.
- 코너 댐퍼는 진동을 억제하여 조용한 노이즈를 합니다.
- 그레브 임펠러를 사용하면 조용한 게임을 경험할 수 있습니다.
- 최대 출력 매개변수: 냉각수 흐름, 핀 표면적, 냉각판 두께.
- 최신 인텔 LGA1851 및 AMD AM5 소켓과 호환되는 구리 냉각 플레이트.
- 5년 보증.

日本語

- ラジエーターファンのパフォーマンスとノイズの完全な比率。
- ファンフレームデザインは、最適なエアフローのためにVortexを生成します。
- コーナー減振器は振動を抑制し、振動ノイズを減らします。
- 溝付きのインペラーを使用すると、サイレントゲームを体験できます。
- 伝導パラメーターを最大化しました:クーラントフロー、フィン表面積、冷却プレート厚さ。
- 最新のIntel LGA1851およびAMD AM5ソケットと互換性のある銅冷却プレート。
- 5年保証。

FRENCH

- Rapport parfait des performances du ventilateur de radiateur au bruit.
- La conception du cadre du ventilateur génère du vortex pour un flux d'air optimal.
- Les amortisseurs d'angle suppriment l'oscillation, réduisant le bruit des vibrations.
- La roue rainurée vous permet de vivre un jeu silencieux.
- Paramètres de conduction au maximum: débit de liquide de refroidissement, surface de la nageoire, épaisseur de la plaque de refroidissement.
- Plaque de refroidissement en cuivre compatible avec les dernières prises Intel LGA1851 et AMD AM5.
- Garantie de 5 ans.

DEUTSCH

- Perfektes Verhältnis von Kühlerleistung zu Rauschen.
- Das Design des Lüfterrahmens erzeugt Wirbel für einen optimalen Luftstrom.
- Eckdämpfer unterdrücken die Oszillation und reduzieren Schwingungsgerauschen.
- Mit einem gerillten Laufrad können Sie stille Spiele erleben.
- Maximierte Leitungsparameter: Kühlmittelfluss, Flossenoberfläche, Kühlplattendicke.
- Kupferkühlplatte kompatibel mit den neuesten Intel LGA1851- und AMD AM5-Sockets.
- 5-Jahres-Garantie.

ESPAÑOL

- Relación perfecta del rendimiento del ventilador del radiador al ruido.
- El diseño del marco del ventilador genera vórtice para un flujo de aire óptimo.
- Los amortiguadores de la esquina suprimen la oscilación, reduciendo el ruido de vibración.
- El impulsor acanalado le permite experimentar juegos silenciosos.
- Parámetros de conducción al máximo: flujo de refrigerante, área de superficie de aleta, espesor de la placa de enfriamiento.
- Placa de enfriamiento de cobre compatible con los últimos enchufes Intel LGA1851 y AMD AM5.
- Garantía de 5 años.

簡中

- 最佳性能與噪音的完美平衡。
- 風扇機架設計生成渦流以提供最佳風量。
- 圓角減震器能抑制震動，減少震動噪音。
- 溝槽式扇葉設計帶來靜音遊戲。
- 最高導熱參數：冷卻液流量、扇片面積、冷卻板厚度。
- 銅製散熱片與最新的 Intel LGA1851 及 AMD AM5 腳位。
- 五年保固。

繁中







- 最佳性能與噪音的完美平衡。
- 風扇機架設計生成渦流以提供最佳風量。
- 圓角減震器能抑制震動，減少震動噪音。
- 溝槽式扇葉設計帶來靜音遊戲。
- 最高導熱參數：冷卻液流量、扇片面積、冷卻板厚度。
- 銅製散熱片與最新的 Intel LGA1851 及 AMD AM5 腳位。
- 五年保固。

SPECIFICATIONS 产品规格, 產品規格

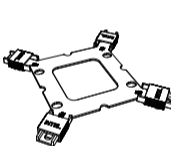
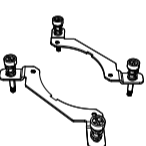
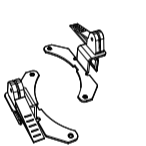
WATER BLOCK & PUMP 水冷头 & 幫浦, 水冷頭 & 幫浦	
Model Name 产品型号, 產品型號	Poseidon Ultra ARGB 360 / 240
Dimensions (WxDxH) 尺寸, 尺寸	83.5 x 71 x 68mm
Cold Plate Material 水冷板材质, 水冷板材質	Copper 铜, 銅
Pump Speed 幫浦转速, 幫浦轉速	3000 ± 10% RPM
Rated Voltage 额定电压, 額定電壓	12 VDC
Rated Current 额定电流, 額定電流	0.23 A
Power Consumption 电力功耗, 電力功耗	2.76 W
RADIATOR 水冷排, 水冷排	
Dimensions (WxDxH) 尺寸, 尺寸	(240) 277 x 120 x 27mm (360) 394 x 120 x 27mm
Material 材质, 材質	Aluminium Alloy 铝合金, 鋁合金
TUBING 水冷管, 水冷管	
Length 长度, 長度	400 mm

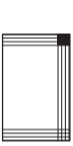
FANS 风扇, 風扇	
Fan Quantity 风扇数量, 風扇數量	Poseidon Ultra ARGB 240 : 2 Poseidon Ultra ARGB 360 : 3
Dimensions (WxDxH) 尺寸, 尺寸	120 x 120 x 25 mm
Bearing 轴承, 軸承	HDB (Hydro-Dynamic-Bearing)
Fan Speed 风扇转速, 風扇轉速	500-2200 RPM ±10%
Air Flow 风量, 風量	64.95 CFM
Air Pressure 风压, 風壓	3.26 mmH2O
Acoustic Noise 运转声响, 運轉聲響	32.1 dB(A)
Power Consumption 电力功耗, 電力功耗	2.16 W (Fan) / 1.75 W (LED)
Rated Current 额定电流, 額定電流	0.37A (Fan) / 0.35 A (LED)
Rated Voltage 额定电压, 額定電壓	12 VDC (Fan) / 5 VDC (LED)
Connector & Control 接头 & 控制线, 接頭 & 控制線	Fan 转速, 轉速: 2510-4Pin PWM Lights 灯效, 燈效: 5V-3Pin ARGB
CPU Socket CPU插座, CPU插座	Intel LGA1851 / LGA1700 / LGA1200 / LGA115X AMD AM5 / AM4 / AM3 / AM2 / FM2 / FM1

INSTALL CONTENTS 配件清单, 配件清單

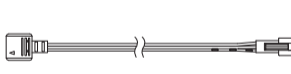
 Fan 风扇, 風扇 240 x 2 / 360 x 3	 Intel Backplate Intel背板, Intel背板	 Intel Mounting Bracket Intel扣具, Intel扣具	 AMD Mounting Bracket AMD扣具, AMD扣具	 Screw for Bracket 扣具螺絲, 扣具螺絲	 Thermal Grease 导热膏, 導熱膏
 Fan Screw 风扇螺丝, 風扇螺絲 240 x 8 360 x 12	 Radiator Screw 水排螺丝, 水排螺絲 240 x 8 360 x 12	 Fan Extension Cable 風扇延長線	 ARGB Light Extension Cable ARGB燈控延長線		

Intel LGA1851 / LGA1700 / LGA1200 / LGA115X

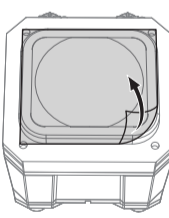

1

Please remove the protection tape before installing.
請在安裝前撕掉銅底保護膜。

WARNING
When changing the logo orientation, please rotate counterclockwise. Do not pull to avoid damaging the attachment mechanism.
警告: 更改 Logo 方向时, 請逆時針旋轉。切勿拉扯以避免破壞卡鉤結構。
警告: 更改 Logo 方向時, 請逆時針旋轉。切勿拉扯以避免破壞卡鉤結構。

2

Please follow the sequence above to lock the bracket, and make sure the thumb screws are well installed.
請依照上述對角交叉順序, 使用螺絲起子鎖緊螺母, 並確保螺母安裝到位。

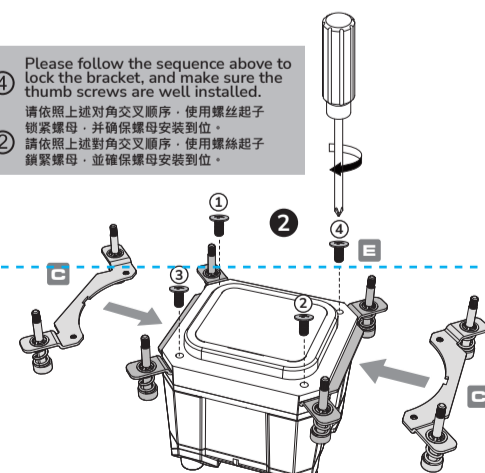

3

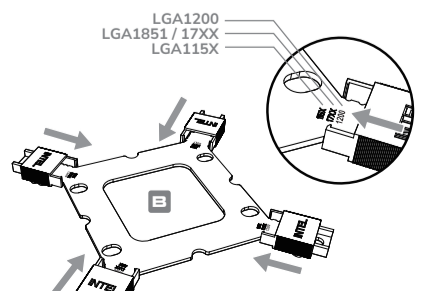

LGA1200
LGA1851 / 17XX
LGA115X

4-1

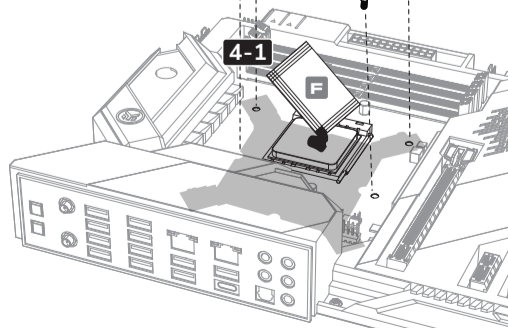

4-2

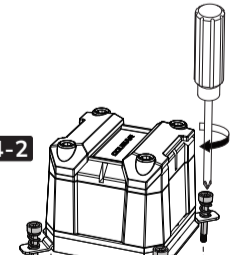

1

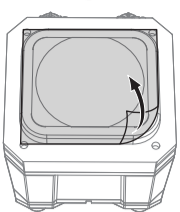

! Please remove the protection tape before installing.
請在安裝前撕掉銅底保護膜。

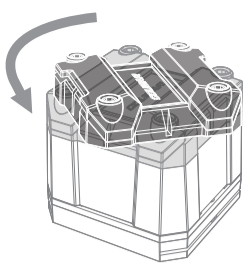

WARNING
When changing the Logo orientation, please rotate counterclockwise. Do not pull to avoid damaging the attachment mechanism.

警告：更改 Logo 方向時，請逆時針旋轉，切勿拉扯以避免破壞卡鉤結構。
警告：更改 Logo 方向時，請逆時針旋轉，切勿拉扯以避免破壞卡鉤結構。

Please follow the sequence above to lock the bracket, and make sure the thumb screws are well installed.
請依照上述對角交叉順序，使用螺絲起子鎖緊螺母，並確保螺母安裝到位。
請依照上述對角交叉順序，使用螺絲起子鎖緊螺母，並確保螺母安裝到位。

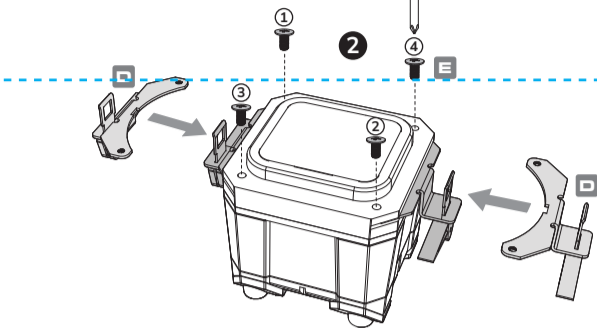

3-2

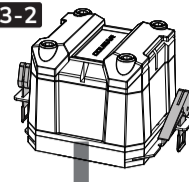

3-1

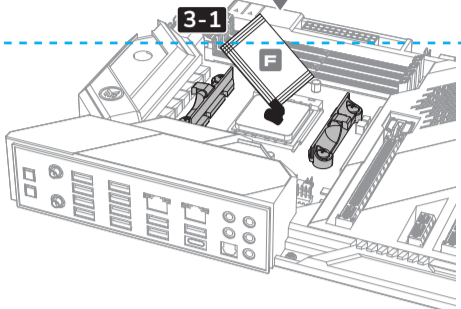

4-1

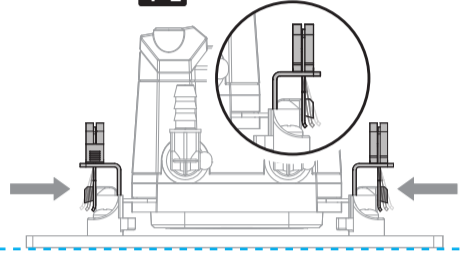

4-2

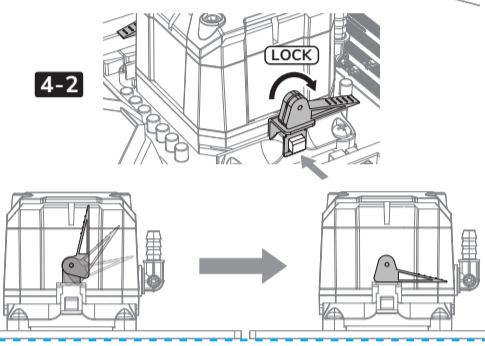

INSTALLATION 安裝, 安裝

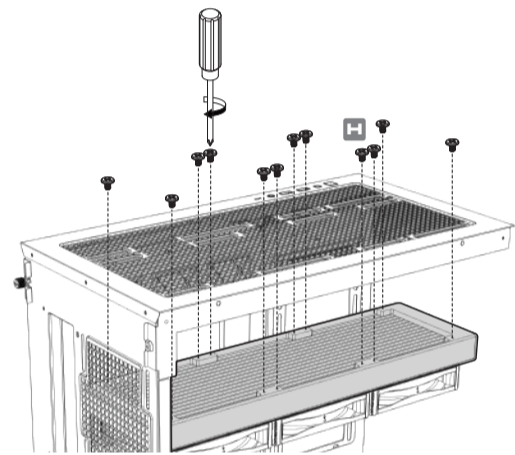
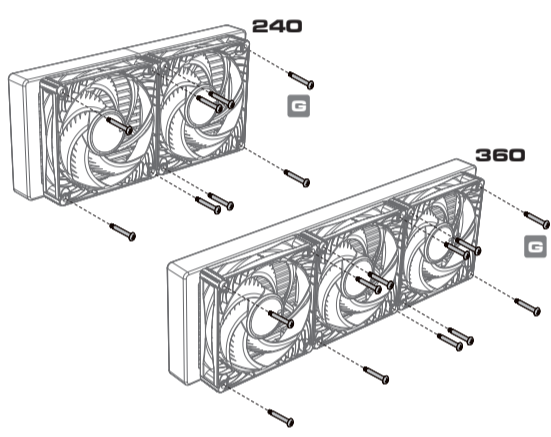

! Please do not connect on the 4pin 12V header.
注意：請勿連接4pin 12V接口
注意：請勿連接4pin 12V接口



Please check your motherboard is compatible with 5V 3pin Addressable RGB Header.
請先確認您的主板支援5V 3pin ARGB可編程接口
請先確認您的主板支援5V 3pin ARGB可編程接口

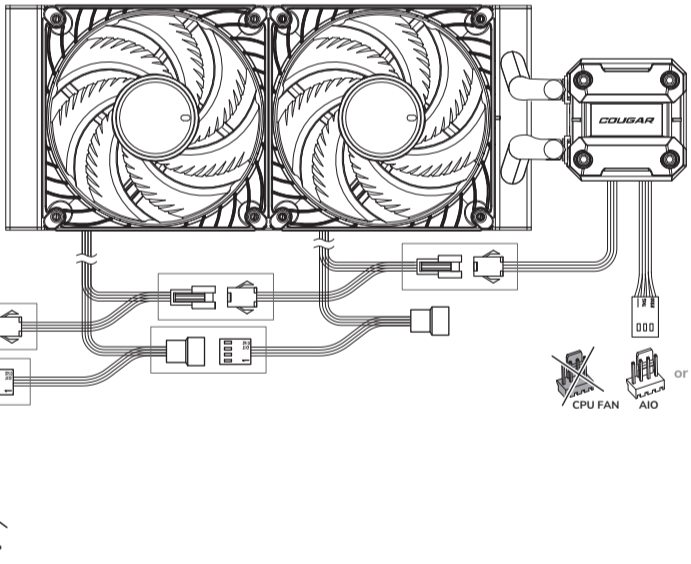

Matters needing attention:

1. Please connect the ARGB port to the motherboard header or the ARGB controller.
 2. The power port of pump head must be connected to AIO PUMP port, otherwise it will seriously affect the performance.
 3. If there is no AIO PUMP port, please plug into the system fan port and set the port fan mode to PWM mode.
- 注意事項:**
1. 請將ARGB接頭連接到主板接口或是ARGB控制器。
 2. 水冷頭電源線必須連接在AIO PUMP插座，否則會嚴重影響性能。
 3. 如果沒有AIO PUMP插座，請將水冷頭電源線接到系統風扇插座，並把風扇模式設置為PWM模式。
- 注意事項:**
1. 請將ARGB接頭連接到主板接口或是ARGB控制器。
 2. 水冷頭電源線必須連接在AIO PUMP插座，否則會嚴重影響性能。
 3. 如果沒有AIO PUMP插座，請將水冷頭電源線接到系統風扇插座，並把風扇模式設置為PWM模式。

POSEIDON ULTRA ARGB 240

Poseidon Ultra ARGB 240	Fan x 2	User Manual x 1
Mounting Kit x 1	4Pin PWM Fan Extension Cable x 1	5V 3Pin ARGB Light Extension Cable x 1

POSEIDON ULTRA ARGB 360

Poseidon Ultra ARGB 360	Fan x 3	User Manual x 1
Mounting Kit x 1	4Pin PWM Fan Extension Cable x 1	5V 3Pin ARGB Light Extension Cable x 1

GLOBAL WARRANTY POLICY 全球保固政策, 全球保固政策

WARRANTY PERIODS OF COUGAR GAMING DEVICES
Product : COUGAR Poseidon Ultra ARGB 360 / 240
Warranty : 5 Years, 5年保固, 5年保固
This warranty gives you specific legal rights. You may also have other rights granted under local law. These rights may vary.

CONDITIONS WHERE FREE MAINTENANCE IS NOT PROVIDED

- Any fault or damage caused by natural disasters (including storm, fire, flood, thunder, earthquake, etc).
- Any fault or damage caused by accidental factors and man-made reasons (including hit, scrape, crash, moving, compression, stain, corrosion, use of incurred on unsuitable voltage, computer virus, riot, misuse, malicious damage, etc).
- Use in an improper operating environment (including high temperature, high humidity, water inflow, etc).
- Inability to provide the product warranty card, purchase receipt or invoice to prove the product is still within the warranty period and the shipping date of the product is out of warranty.
- The warranty card or product serial number has been altered or its number is hard to identify.
- The warranty period has expired.
- Any fault or damage caused by non-compliance with regulations stated on the user manual or improper, rough and careless treatment.
- Any fault or damage caused by use of parts not certified by COUGAR original manufacturer.
- The problem is caused by improper repair or adjustment by the buyer or any manufacturer without authorization from COUGAR.
- The product is not acquired from an authorized distributor of the company or is acquired from illicit sources.
- Paper carton, instruction and other accessories are not warranted.

DISCLAIMERS

- COUGAR product is not authorized for use as critical components in life support device or for incorrect application software or malfunction of the product.
- COUGAR is not liable for the death or damage of person or loss of property when product is using as, including but not limited to, medical equipment, military equipment, traffic equipment and disaster prevention system.
- COUGAR is not liable for any damages, expenses, lost data, lost revenues, lost savings, lost profits, or any incidental or consequential damages due to using defect product of COUGAR.

WARRANTY AGREEMENT

- If the product has defects in material or manufacture, COUGAR will provide product repair and replacement service within the warranty period.
- Our warranty service is based on the date of the invoice or warranty card (must be affixed with the store stamp).
If you lose the aforementioned evidence, we will apply the original shipping date of the product as the beginning date of warranty period. The shipping date will be identified by the product serial number(S/N).

LEGAL NOTICES

This manual was created by Compucase Enterprise and may not be completely or partially copied, passed on, distributed or stored without written consent by Compucase Enterprise.
COUGAR® is a registered brand of Compucase Enterprise. Other product and company names mentioned in this documentation may be brands or trademarks of their respective owners.
Compucase Enterprise reserves the right to make changes concerning the contents of the manual and the technical data of the product without previous announcement.

MANUFACTURER CONTACT

COUGAR
www.cougargaming.com

COUGAR USA Technical Service
Tel: (833) 256-3778
Mail:rma@compucaseusa.com
Compucase Enterprise Co.,Ltd.
All rights reserved. Made in China



Official website

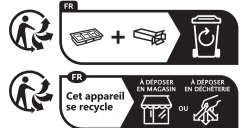

Points de collecte sur www.cougarindomochests.fr
Préférez la réparation ou le don de votre appareil !